









Technical Data

UL approval	cULus Listed, General Purpose, Class 2 Power Source
Ambient conditions	
Operating temperature	0 ... 60 °C (32 ... 140 °F) Standard , with Option T -40 ... 85 °C (-40 ... 185 °F)
Storage temperature	-40 ... 85 °C (-40 ... 185 °F)
Mechanical specifications	
Material	housing: powder coated aluminum flange: aluminum shaft: stainless steel
Mass	approx. 500 g
Rotational speed	max. 12000 min ⁻¹ without shaft seal max. 3000 min ⁻¹ with shaft seal
Moment of inertia	30 gcm ²
Starting torque	≤ 3 Ncm without shaft seal ≤ 5 Ncm with shaft seal
Shaft load	
Axial	40 N
Radial	110 N

Accessories

	9203	Angled flange
	V1SD-G-ABG-PG9	Male connector M12 straight D-coded 4-pin, for cable diameter 5 - 8 mm, shielded, field-attachable
	V1SD-G-2M-PUR-ABG-V45-G	Connection cable, M12 to RJ-45, PUR cable 4-pin, CAT5e
	V15-G-YE2M-PVC	Female cordset, M12, 5-pin, PVC cable
	9300	Mounting bracket for servo flange
	V15-G-YE5M-PVC	Female cordset, M12, 5-pin, PVC cable
	V15-G-PG9	Female connector M12 straight A-coded 5-pin, for cable diameter 6 - 8 mm, field-attachable
	MBT-36ALS	Spring-loaded mounting bracket with a diameter of 36 mm

Release date: 2022-12-12 Date of issue: 2022-12-12 Filename: t29491_eng.pdf

Refer to "General Notes Relating to Pepperl+Fuchs Product Information".

Pepperl+Fuchs Group
www.pepperl-fuchs.com

USA: +1 330 486 0001
fa-info@us.pepperl-fuchs.com

Germany: +49 621 776 1111
fa-info@de.pepperl-fuchs.com

Singapore: +65 6779 9091
fa-info@sg.pepperl-fuchs.com

 **PEPPERL+FUCHS**

Connection

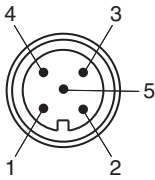
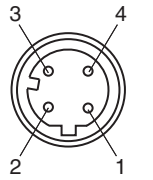
Pin	Male connector M12 x 1, 5-pin, A-coded	Female connector M12 x 1, 4-pin, D-coded
1	+ 24 V	Tx +
2	+ 24 V	Rx +
3	0 V	Tx -
4	0 V	Rx -
5	PE	
		

Indication

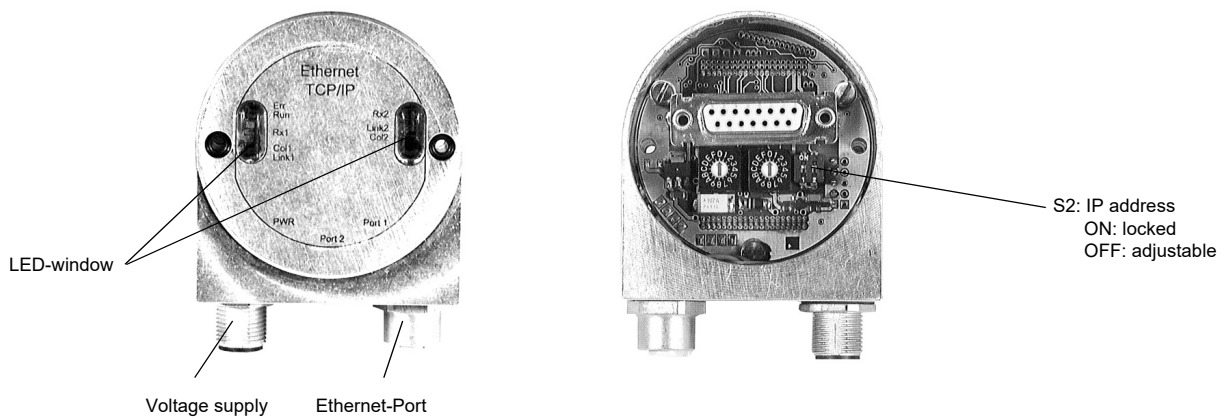

LED-indicators

LED	Colour	Meaning
Rx1	yellow	Data traffic on Port 1
Link1	green	Connection to an Ethernet device on Port 1
Col1	red	Bus collision on Port 1
Err	red	Internal error
Run	green	Ethernet interface ready to work

IP address adjustment

Set switch S2 to position OFF. The IP address can be adjusted now. In switch position ON, the IP address is blocked to avoid unintended change. The rotary switches and switch S1 are without any function.

Type Code

Release date: 2022-12-12 Date of issue: 2022-12-12 Filename: t29491_eng.pdf

Refer to "General Notes Relating to Pepperl+Fuchs Product Information".

- Avoid any impact on the housing and in particular on the encoder shaft as well as the axial and radial overload of the encoder shaft.
- The accuracy and service life of the encoder is guaranteed only, if a suitable coupling is used.
- The operating voltage for the encoder and the follow-up device (e. g. control) has to be switched on and off simultaneously.
- Any wiring work has to be carried out with the system in a dead condition.
- The maximum operating voltages must not be exceeded. The devices have to be operated at extra-low safety voltage.

Notes on connecting the electric screening

The immunity to interference of a plant depends on the correct screening. In this field installation faults occur frequently. Often the screen is applied to one side only, and is then soldered to the earthing terminal with a wire, which is a valid procedure in LF engineering. However, in case of EMC the rules of HF engineering apply.

One basic goal in HF engineering is to pass the HF energy to earth at an impedance as low as possible as otherwise energy would discharge into the cable. A low impedance is achieved by a large-surface connection to metal surfaces.

The following instructions have to be observed:

- Apply the screen on both sides to a "common earth" in a large surface, if there is no risk of equipotential currents.
- The screen has to be passed behind the insulation and has to be clamped on a large surface below the tension relief.
- In case of cable connections to screw-type terminals, the tension relief has to be connected to an earthed surface.
- If plugs are used, metallised plugs only should be fitted (such as sub D plugs with metallised housing). Please observe the direct connection of the tension relief to the housing.

Advantage:	metallised connector, shield
	clamped with the strain relief
	clamp
Disadvantage:	soldering shield on

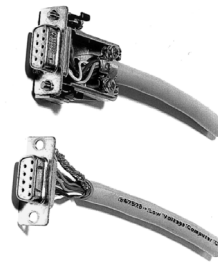

Safety instructions

Please observe the national safety and accident prevention regulations as well as the subsequent safety instructions in these operating instructions when working on encoders.

If failures cannot be remedied, the device has to be shut down and has to be secured against accidental operation.

Repairs may be carried out only by the manufacturer. Entry into and modifications of the device are not permissible.

Tighten the clamping ring only, if a shaft has been fitted in the area of the clamping ring (hollow shaft encoders).

Tighten all screws and plug connectors prior to operating the encoder.

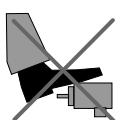

Do not stand on the encoder!

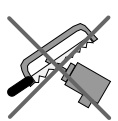

Do not remachine the drive shaft!

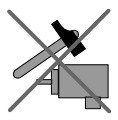

Avoid impact!



Do not remachine the housing!

Release date: 2022-12-12 Date of issue: 2022-12-12 Filename: t29491_eng.pdf