

Multiturn absolute encoder ESM58-IZ

- Industrial standard housing Ø58 mm
- EtherNet/IP
- Up to 30 Bit multiturn
- Recessed hollow shaft
- Network loop through by means of integrated 2 port switch
- IP address resettable
- No DIP switches for address setting
- Compatible with Rockwell/ Allen Bradley/ Schneider control
- Mechanical compatibility with all major encoders with fieldbus interface
- Rotary axis functionality
- Status LEDs
- Ethernet IP declaration of conformity
- CIP encoder profile



Function

In addition to the CANopen-, DeviceNet-, PROFIBUS- and AS-Interface encoders, we have broadened our product line of bus-capable absolute encoders with the ESM58 for Ethernet.

Absolute multiturn rotary encoders deliver an absolute step value for each angle setting. This device has a maximum basic resolution of 65536 steps per revolution (16 bits) and codes up to 16384 revolutions (14 bits). Thus the overall resolution amounts to 30 bits. On account of the high number of measuring steps resulting (more than 1 billion), this type of encoder can be used to divide very long linear distances into small measuring steps.

Dimensions

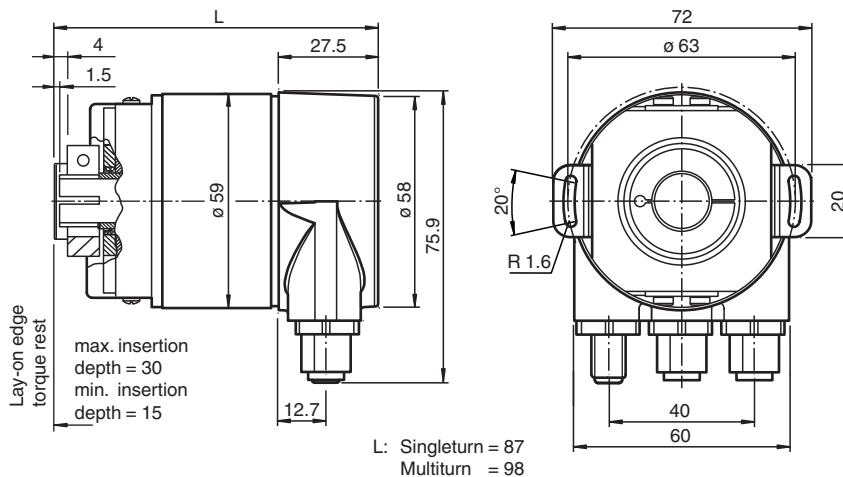

Technical Data

General specifications	
Detection type	photoelectric sampling
Device type	Multiturn absolute encoder
Functional safety related parameters	
MTTF _d	120 a
Mission Time (T _M)	20 a
L _{10h}	1.9 E+11 at 6000 rpm and 20/40 N axial/radial shaft load
Diagnostic Coverage (DC)	0 %





Refer to "General Notes Relating to Pepperl+Fuchs Product Information".

Technical Data

Electrical specifications		
Operating voltage	U_B	10 ... 30 V DC
Power consumption	P_0	max. 4 W
Linearity		± 0.5 LSB (12 Bit) ,
Output code		binary code
Code course (counting direction)		programmable, cw ascending (clockwise rotation, code course ascending) cw descending (clockwise rotation, code course descending)
Interface		
Interface type		EtherNet/IP
Resolution		
Single turn		up to 16 Bit
Multiturn		14 Bit
Overall resolution		up to 30 Bit
Physical		Ethernet
Transfer rate		100 MBit/s
Connection		
Connector		Ethernet: 2 sockets M12 x 1, 4-pin, D-coded Supply: 1 plug M12 x 1, 4-pin, A-coded
Standard conformity		
Degree of protection		DIN EN 60529, shaft side: IP64 (without shaft seal)/IP66 (with shaft seal) housing side: IP65 Stainless steel version (INOX): completely IP67
Climatic testing		DIN EN 60068-2-3, no moisture condensation
Emitted interference		EN 61000-6-4:2007
Noise immunity		EN 61000-6-2:2005
Shock resistance		DIN EN 60068-2-27, 100 g, 6 ms
Vibration resistance		DIN EN 60068-2-6, 10 g, 10 ... 2000 Hz
Approvals and certificates		
UL approval		cULus Listed, General Purpose, Class 2 Power Source
Ambient conditions		
Operating temperature		0 ... 60 °C (32 ... 140 °F)
Storage temperature		-40 ... 85 °C (-40 ... 185 °F)
Mechanical specifications		
Material		housing: powder coated aluminum flange: aluminum shaft: stainless steel
Combination 1		housing: powder coated aluminum flange: aluminum shaft: stainless steel
Combination 2 (Inox)		housing: stainless steel 1.4305 / AISI 303 flange: stainless steel 1.4301 / AISI 304 shaft: stainless steel 1.4305 / AISI 303
Mass		approx. 370 g (combination 1) approx. 840 g (combination 2)
Rotational speed		max. 12000 min ⁻¹
Moment of inertia		30 gcm ²
Starting torque		≤ 3 Ncm (version without shaft seal)
Tightening torque, fastening screws		max. 1.8 Nm
Shaft load		
Angle offset		$\pm 0.9^\circ$
Axial offset		static: ± 0.3 mm, dynamic: ± 0.1 mm
Radial offset		static: ± 0.5 mm, dynamic: ± 0.2 mm

Release date: 2022-12-12 Date of issue: 2022-12-12 Filename: t48723_eng.pdf

Accessories

	ACC-PACK-ABS-_S_58 ø15	Accessories set for Ø58 absolut rotary encoder with recessed hollow shaft 15 mm
	ACC-PACK-ABS-_S_58 ø14	Accessories set for Ø58 absolut rotary encoder with recessed hollow shaft 14 mm
	ACC-PACK-ABS-_S_58 ø12	Accessories set for Ø58 absolut rotary encoder with recessed hollow shaft 12 mm
	ACC-PACK-ABS-_S_58 ø10	Accessories set for Ø58 absolut rotary encoder with recessed hollow shaft 10 mm

Connection

Pin	Male connector M12 x 1, 4-pin, A-coded	Female connector M12 x 1, 4-pin, D-coded
1	Supply voltage +U _B	Tx +
2	-	Rx +
3	0 V	Tx -
4	-	Rx -

Indication

Diagnostic LEDs

LED	Color	Description for LED = ON
Active1	Yellow	Incoming and outgoing data traffic for port 1
Link1*	Green	Connection to other Ethernet devices on port 1
Active2	Yellow	Incoming and outgoing data traffic for port 2
Link2*	Green	Connection to other Ethernet devices on port 2
Stat1	Green	Status 1, details see table below
Stat2	Red	Status 2, details see table below

* flashes with 2 Hz if engineering identification call is activated and link connection is available

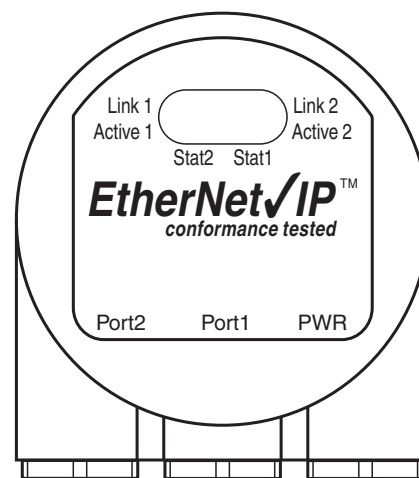

Stat1 (green)	Stat2 (red) bus failure	Meaning	Cause
off	off	No power	
on	on	No connection to another device Criteria: no data exchange	<ul style="list-style-type: none"> • bus disconnected • Master not available / switched off
on	flashes ¹⁾	Parameterization fault, no data exchange Criteria: data exchange correct. However, the slave did not switch to the data exchange mode.	<ul style="list-style-type: none"> • Slave not configured yet or wrong configuration • Wrong station address assigned (but not outside the permitted range) • Actual configuration of the slave differs from the nominal configuration
on	off	Data exchange. Slave and operation ok.	

1) flashing frequency 0.5 Hz for at least 3 seconds

Type Code

Release date: 2022-12-12 Date of issue: 2022-12-12 Filename: t48723_eng.pdf

Order code

E S M 5 8 N - I Z R 0 B N -

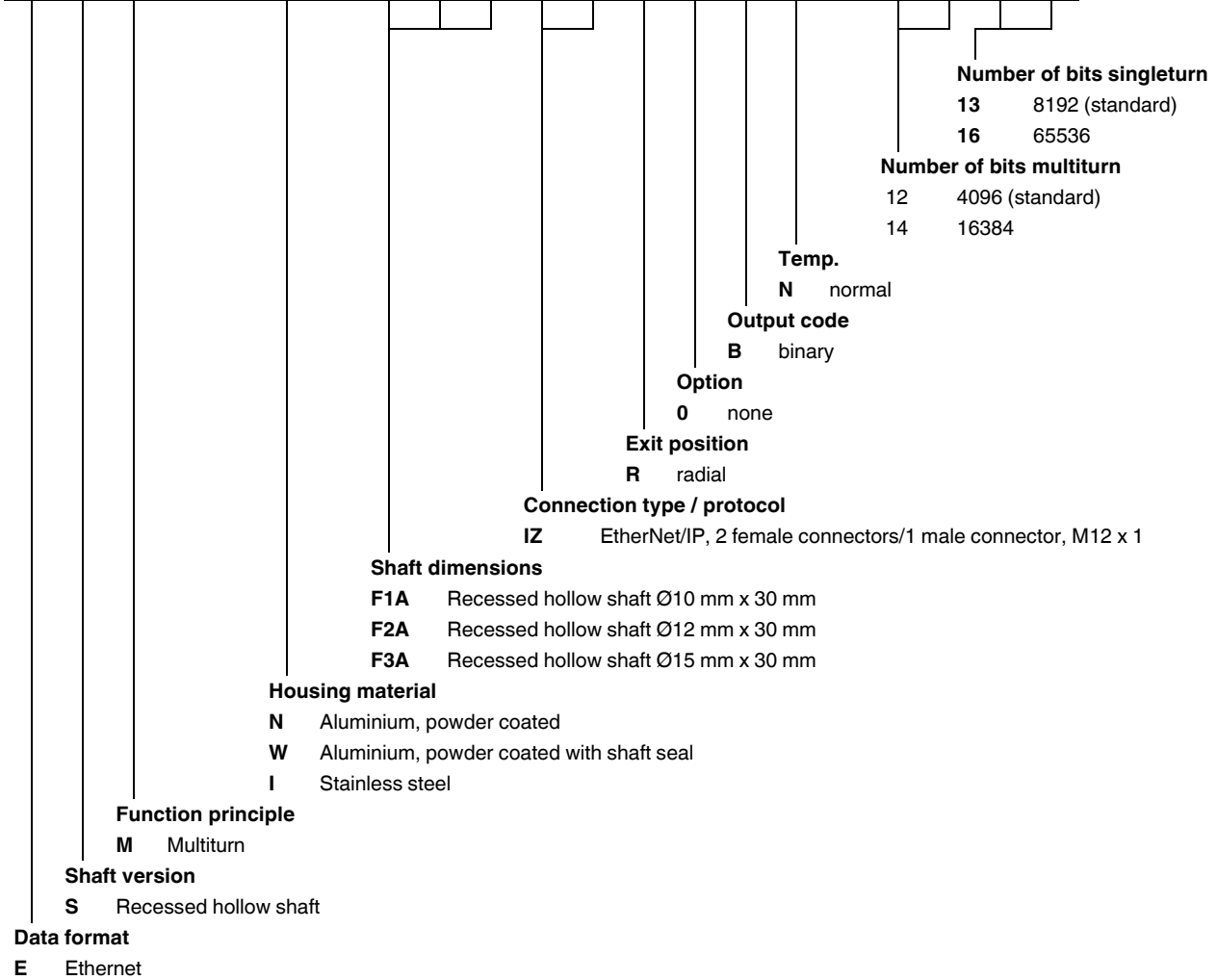

Release date: 2022-12-12 Date of issue: 2022-12-12 Filename: t48723_eng.pdf

Refer to "General Notes Relating to Pepperl+Fuchs Product Information".