



Multiturn absolute encoder

CSM58

- Industrial standard housing $\varnothing 58$ mm
- Recessed hollow shaft
- 30 Bit multiturn
- Galvanically isolated CAN interface
- 2 limit switches
- 8 programmable cams
- Velocity and acceleration output
- Event triggered process data transfer



Function

Absolute encoders deliver an absolute step value for each angle setting. All these values are represented by code samples on one or more code disks which are sampled by a photoelectric array.

The absolute encoder has a maximum basic resolution of 65536 steps per revolution (16 Bits). In the multiturn design, additional up to 16384 revolutions (14 Bits) can be resolved. This results in a total maximum resolution of 1073741824 steps (30 Bits).

The encoders integrated CAN bus interface supports all CANopen functions. The following operating modes can be programmed, and can be selectively turned on or off:

- Polled mode
- Cyclic mode
- Sync mode

The absolute encoder is mounted directly onto the application shaft, without any coupling. Rotation of the absolute encoder is prevented by a torque rest.

The bus electronics module is integrated into the removable housing cover. This makes it possible to mount or replace the new rotary encoders and the matching bus electronics separately during installation or service.

Dimensions

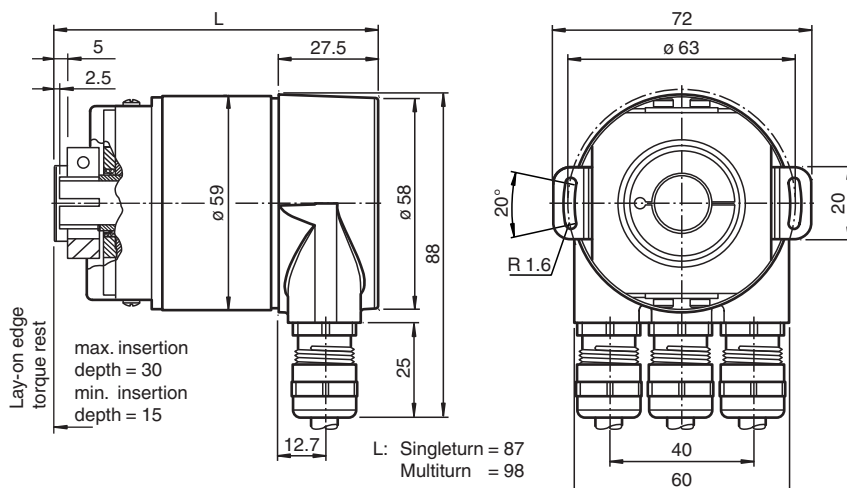

Technical Data

General specifications

Detection type	photoelectric sampling
Device type	Multiturn absolute encoder

Electrical specifications

Operating voltage	U_B	10 ... 30 V DC
No-load supply current	I_0	max. 230 mA at 10 V DC max. 100 mA at 24 V DC

Release date: 2023-02-14 Date of issue: 2023-02-14 Filename: t49163_eng.pdf

Refer to "General Notes Relating to Pepperl+Fuchs Product Information".

Pepperl+Fuchs Group
www.pepperl-fuchs.com

USA: +1 330 486 0001
fa-info@us.pepperl-fuchs.com

Germany: +49 621 776 1111
fa-info@de.pepperl-fuchs.com



Singapore: +65 6779 9091
fa-info@sg.pepperl-fuchs.com

PF PEPPERL+FUCHS

Technical Data

Time delay before availability	t_v	< 250 ms
Linearity		± 2 LSB at 16 Bit, ± 1 LSB at 13 Bit, $\pm 0,5$ LSB at 12 Bit
Output code		binary code
Code course (counting direction)		cw ascending (clockwise rotation, code course ascending) cw descending (clockwise rotation, code course descending)
Interface		
Interface type		CANopen
Resolution		
Single turn		up to 16 Bit
Multiturn		14 Bit
Overall resolution		up to 30 Bit
Transfer rate		max. 1 MBit/s
Standard conformity		communication profile: DS 301 Device profiles: DS 406 and DS 417 , programmable according to class 2
Connection		
Terminal compartment		in removable housing cover
Standard conformity		
Degree of protection		DIN EN 60529, IP65 IP66 (with shaft seal)
Climatic testing		DIN EN 60068-2-30 , no moisture condensation
Emitted interference		EN 61000-6-4:2007
Noise immunity		EN 61000-6-2:2005
Shock resistance		DIN EN 60068-2-27, 100 g, 6 ms
Vibration resistance		DIN EN 60068-2-6, 20 g, 10 ... 2000 Hz
Approvals and certificates		
UL approval		cULus Listed, General Purpose, Class 2 Power Source
Ambient conditions		
Operating temperature		-40 ... 85 °C (-40 ... 185 °F)
Storage temperature		-40 ... 85 °C (-40 ... 185 °F)
Mechanical specifications		
Material		
Combination 1		housing: powder coated aluminum flange: aluminum shaft: stainless steel
Combination 2 (Inox)		housing: stainless steel flange: stainless steel shaft: stainless steel
Mass		approx. 600 g (combination 1) approx. 1200 g (combination 2)
Rotational speed		max. 12000 min ⁻¹
Moment of inertia		30 gcm ²
Starting torque		≤ 3 Ncm (version without shaft seal)
Tightening torque, fastening screws		max. 1.8 Nm
Shaft load		
Angle offset		$\pm 0,9^\circ$
Axial offset		static: $\pm 0,3$ mm, dynamic: $\pm 0,1$ mm
Radial offset		static: $\pm 0,5$ mm, dynamic: $\pm 0,2$ mm

Accessories



	AH 58-B1CA-2BW	Connection cover
	ACC-PACK-ABS-_S_58 ø15	Accessories set for Ø58 absolut rotary encoder with recessed hollow shaft 15 mm

Release date: 2023-02-14 Date of issue: 2023-02-14 Filename: t49163_eng.pdf

Refer to "General Notes Relating to Pepperl+Fuchs Product Information".

Pepperl+Fuchs Group
www.pepperl-fuchs.comUSA: +1 330 486 0001
fa-info@us.pepperl-fuchs.comGermany: +49 621 776 1111
fa-info@de.pepperl-fuchs.comSingapore: +65 6779 9091
fa-info@sg.pepperl-fuchs.com
 **PEPPERL+FUCHS**

Accessories

	ACC-PACK-ABS-_S_58 ø14	Accessories set for Ø58 absolut rotary encoder with recessed hollow shaft 14 mm
	ACC-PACK-ABS-_S_58 ø12	Accessories set for Ø58 absolut rotary encoder with recessed hollow shaft 12 mm
	ACC-PACK-ABS-_S_58 ø10	Accessories set for Ø58 absolut rotary encoder with recessed hollow shaft 10 mm

Connection

Terminal	Cable	Explanation
⊥	-	Ground connection for power supply
(+)	Red	Power supply
(-)	Black	Power supply
G	-	CAN ground
L	Blue	CAN low
H	White	CAN high
G	-	CAN ground
L	Blue	CAN low
H	White	CAN high

Configuration

Indicating and operating elements

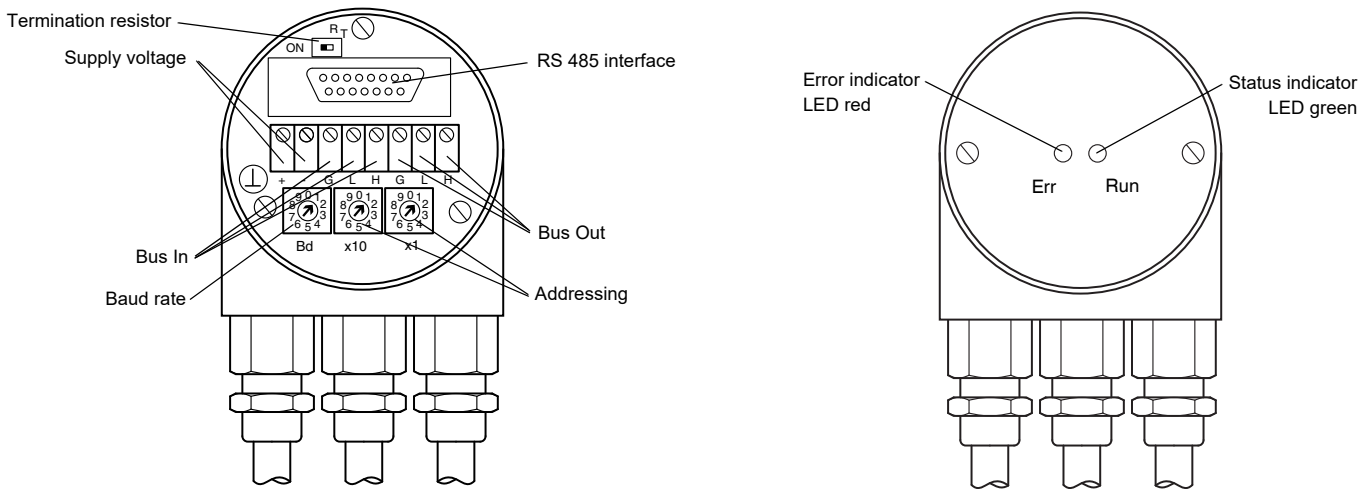

Adjusting the participant address

The participant address can be adjusted with the rotary switches. The address can be defined between 1 and 96, and may only be assigned once. The addresses 97 ... 99 are reserved.

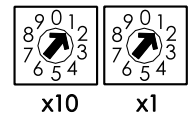

Adjusting the termination resistor

The terminating resistor R_T (121 Ω) can be connected to the circuit by means of the switch:

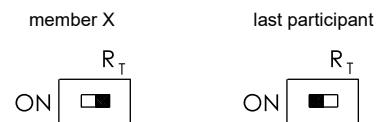

Baud rate adjustment

Baud rate [kBit/s]	Switch position	Baud rate [kBit/s]	Switch position
20	0	500	5
50	1	800	6
100	2	1000	7
125	3	reserved	8
250	4	set baud rate by SDO message and LSS	9

Release date: 2023-02-14 Date of issue: 2023-02-14 Filename: t49163_eng.pdf

LED-indicators

CAN Run (green)	State	Description
flickering	AutoBitrate / LSS	Auto-bitrate detection is in progress or LSS services are in progress
blinking	PREOPERATIONAL	Encoder is in state PREOPERATIONAL
single flash	STOPPED	Encoder is in state STOPPED
double flash		reserved
triple flash	Program / Firmware download	a software download is running on the encoder
on	OPERATIONAL	the encoder is in state OPERATIONAL
Err (red)	State	Description
off	no error	the encoder is in working condition
flickering	AutoBitrate / LSS	Auto-bitrate detection is in progress or LSS services are in progress
blinking	invalid configuration	general configuration error
single flash	Warning limit reached	at least one of the error counters of the CAN controller has reached or exceeded the warning level (too many error frames)
double flash	Error control event	a guard event (NMT-slave or NMT-master) or a heartbeat event (heartbeat consumer) has occurred
triple flash	Sync. error	the sync. message has not been received within the configured communication cycle period time out (see objekt 1006h)
quadruple flash	Error, event-timer	an expected PDO has not been received before the even-timer elapsed
on	Bus off	the CAN controller is bus off

Programming**Programmable CAN operating modes**

Mode	Explanation
Polled mode	The connected host requests the current actual position value via a remote transmission request telegram. The absolute encoder reads in the current position, calculates all parameters that have been set and sends back the process actual value through the same CAN identifier.
Cyclic mode	The absolute encoder sends the current actual process value cyclically, without being prompted by the host. The cycle time can be programmed in milliseconds for values between 1 ms and 65536 ms.
Sync mode	After the sync telegram has been received by the host, the absolute encoder sends the current actual process value. If multiple nodes should respond to the sync telegram, the individual nodes report one after the other according to their CAN identifier. There is no programming of an offset time. The sync counter can be programmed so that the rotary encoder does not transmit until after a defined number of sync telegrams.

Programmable rotary encoder parameters

Parameter	Explanation
Operating parameter	The direction of rotation (complement) can be specified by parameter as the operating parameter. This parameter determines the direction of rotation in which the output code will ascend or descend.
Resolution per revolution	The "Resolution" parameter is used to program the rotary encoder so that a desired number of steps can be implemented in reference to one revolution.
Overall resolution	This parameter indicates the desired number of measurement units of the entire travel length. This value must not exceed the overall resolution of the absolute encoder.
Preset value	The preset value is the desired position value that must be achieved for a specific physical setting of the axis. The preset value parameter is used to set the actual position value to the desired actual process value.
2 limit switches	A total of two positions can be programmed. The absolute encoder sets one bit to high state in the 32 Bit actual process value if a value falls outside the range between these two positions.
8 cam switches	Up to 8 position values can be programmed as cams. By reaching these values bits in object 6300h Cam state register are set.

Type Code

Order code

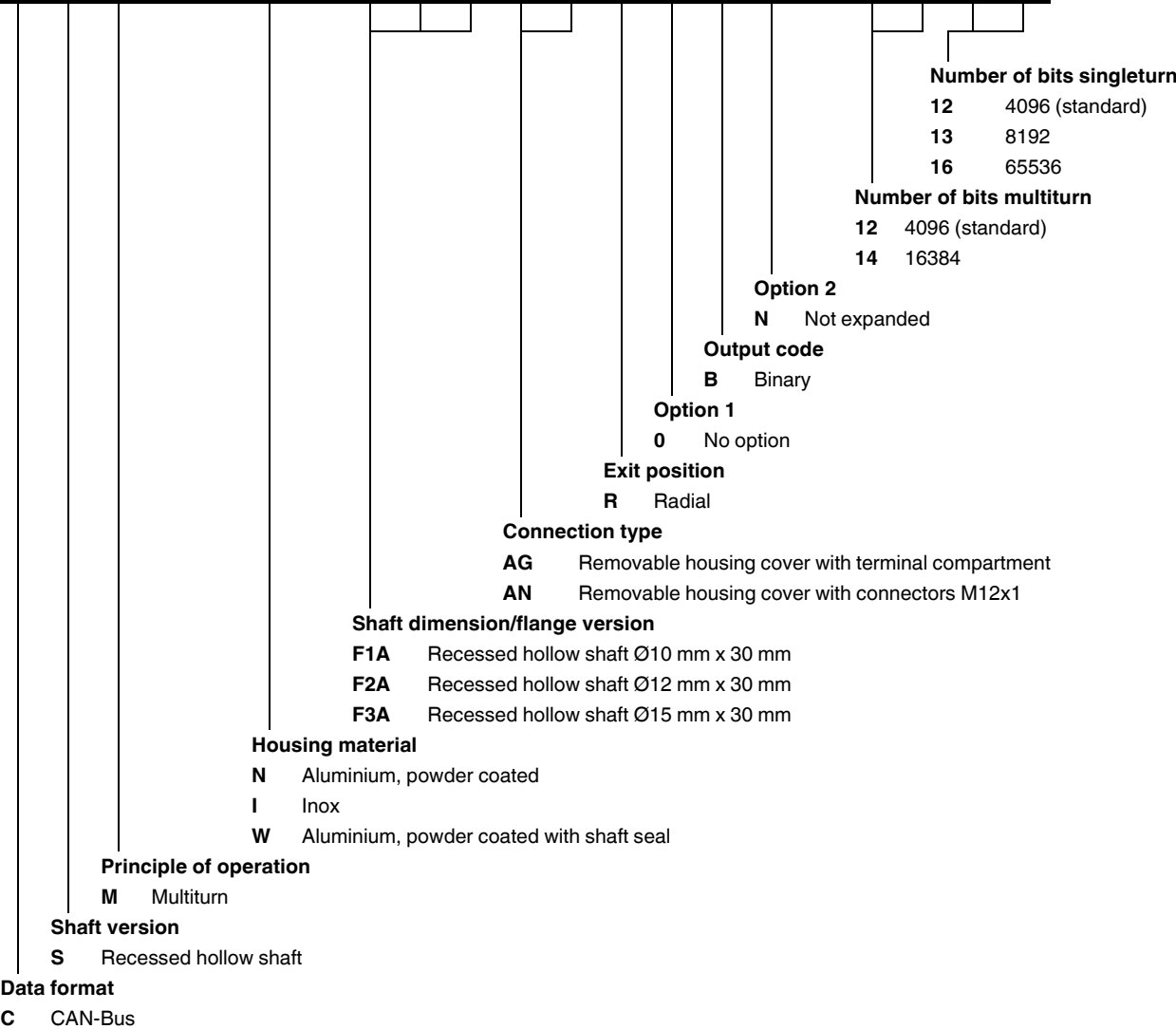

Release date: 2023-02-14 Date of issue: 2023-02-14 Filename: t49163_eng.pdf

Refer to "General Notes Relating to Pepperl+Fuchs Product Information".