



## Multiturn absolute encoder

### AVM58-0

- Industrial standard housing Ø58 mm
- 30 Bit multiturn
- Data transfer up to 2 MBaud
- Optically isolated RS 422 interface
- Servo or clamping flange
- Zero-set function
- Up to 4096 pulses on incremental track



### Function

This multiturn absolute encoder with modern fast technology transmits a position value corresponding to the shaft setting via the SSI interface (Synchronous Serial Interface). The maximum resolution of the AVM58 is maximum 65536 steps per revolution at 16384 revolutions. The devices of the AVM58 series are equipped with a microcontroller.

The control module sends a clock bundle to the absolute encoder to obtain position data. The rotary encoder then sends the position data synchronous to the cycles of the control module. It is possible to select the following items with function inputs the counting direction and the zero-set function (preset value).

This multiturn absolute encoder is available in a clamping flange design with a shaft diameter of Ø10 mm x 20 mm, or in a servo flange design with a shaft diameter of Ø6 mm x 10 mm.

The electrical connection is made by a 12-pin round plug connector. It is also possible to obtain a version with a 1 m cable connector.

### Dimensions

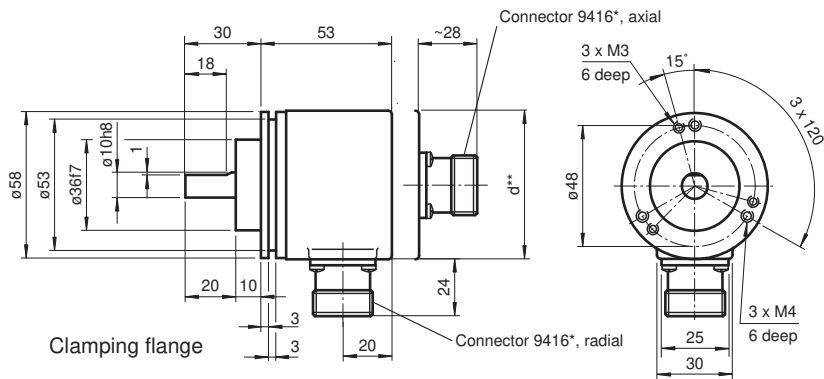

\*\* Aluminium: d = 59, stainless steel: d = 61

Release date: 2023-02-14 Date of issue: 2023-02-14 Filename: t49169\_eng.pdf

Refer to "General Notes Relating to Pepperl+Fuchs Product Information".

Pepperl+Fuchs Group  
www.pepperl-fuchs.com

USA: +1 330 486 0001  
fa-info@us.pepperl-fuchs.com

Germany: +49 621 776 1111  
fa-info@de.pepperl-fuchs.com

Singapore: +65 6779 9091  
fa-info@sg.pepperl-fuchs.com

**PF** PEPPERL+FUCHS

Dimensions

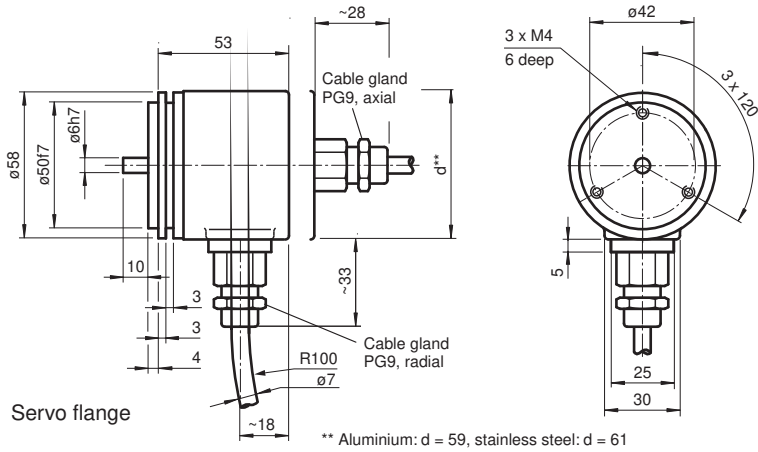
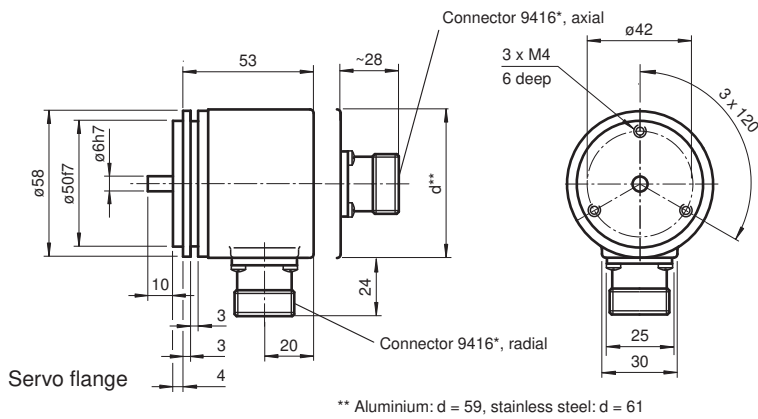
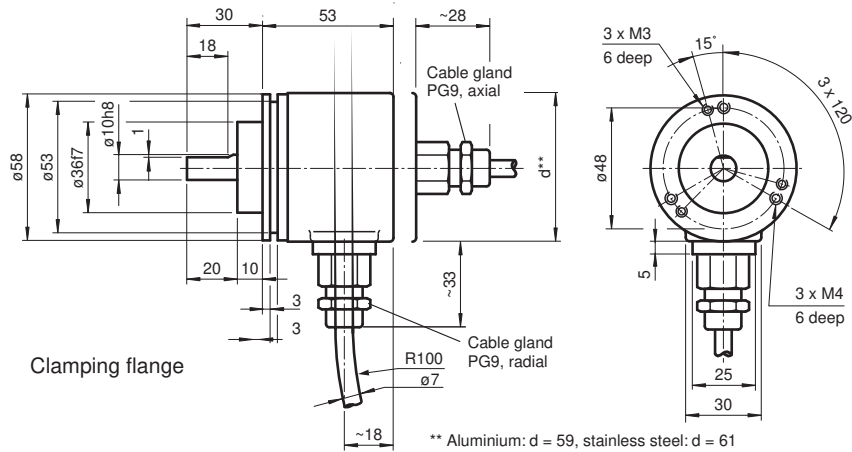

Technical Data

General specifications

Detection type	photoelectric sampling
Device type	Multiturn absolute encoder
UL File Number	E223176 "For use in NFPA 79 Applications only" , if UL marking is marked on the product.

Electrical specifications

Operating voltage	U <sub>B</sub>	4.5 ... 30 V DC (SSI, SSI + RS422) ; 10 ... 30 V DC (SSI + Push/Pull)
No-load supply current	I <sub>0</sub>	max. 180 mA

Release date: 2023-02-14 Date of issue: 2023-02-14 Filename: t49169\_eng.pdf

Refer to "General Notes Relating to Pepperl+Fuchs Product Information".

Pepperl+Fuchs Group  
www.pepperl-fuchs.com

USA: +1 330 486 0001  
fa-info@us.pepperl-fuchs.com

Germany: +49 621 776 1111  
fa-info@de.pepperl-fuchs.com

Singapore: +65 6779 9091  
fa-info@sg.pepperl-fuchs.com

**PF** PEPPERL+FUCHS

## Technical Data

Time delay before availability	$t_v$	< 250 ms
Linearity		$\pm 2$ LSB at 16 Bit, $\pm 1$ LSB at 13 Bit, $\pm 0,5$ LSB at 12 Bit
Output code		Gray code, binary code
Code course (counting direction)		cw descending (clockwise rotation, code course descending)
<b>Interface</b>		
Interface type		SSI ; SSI + incremental track
Monoflop time		$20 \pm 10 \mu\text{s}$
Resolution		
Single turn		up to 16 Bit
Multiturn		14 Bit
Overall resolution		up to 30 Bit
Transfer rate		0.1 ... 2 MBit/s
Voltage drop		$U_B - 2.5 \text{ V}$
Standard conformity		RS 422
<b>Input 1</b>		
Input type		Selection of counting direction (cw/ccw)
Signal voltage		
High		4.5 ... 30 V
Low		0 ... 2 V
Input current		< 6 mA
Switch-on delay		< 10 ms
<b>Input 2</b>		
Input type		zero-set (PRESET 1)
Signal voltage		
High		4.5 ... 30 V
Low		0 ... 2 V
Input current		< 6 mA
Signal duration		min. 100 ms
Switch-on delay		< 10 ms
<b>Output</b>		
Output type		RS422, Push/Pull
Signal output		A+B+/A+/B
Pulses		1024, 2048, 4096
<b>Connection</b>		
Connector		type 9416 (M23), 12-pin, type 9416L (M23), 12-pin
Cable		$\varnothing 7 \text{ mm}$ , $6 \times 2 \times 0.14 \text{ mm}^2$ , 1 m
<b>Standard conformity</b>		
Degree of protection		DIN EN 60529, IP65 (without shaft seal) ; DIN EN 60529, IP66/IP67 (with shaft seal)
Climatic testing		DIN EN 60068-2-3, no moisture condensation
Emitted interference		DIN EN 61000-6-4
Noise immunity		DIN EN 61000-6-2
Shock resistance		DIN EN 60068-2-27, 100 g, 6 ms
Vibration resistance		DIN EN 60068-2-6, 20 g, 10 ... 2000 Hz
<b>Approvals and certificates</b>		
UL approval		cULus Listed, General Purpose, Class 2 Power Source , if UL marking is marked on the product.
<b>Ambient conditions</b>		
Operating temperature		-40 ... 85 °C (-40 ... 185 °F)
Storage temperature		-40 ... 85 °C (-40 ... 185 °F)
<b>Mechanical specifications</b>		
Material		
Combination 1		housing: powder coated aluminum flange: aluminum shaft: stainless steel

Release date: 2023-02-14 Date of issue: 2023-02-14 Filename: t49169\_eng.pdf

Refer to "General Notes Relating to Pepperl+Fuchs Product Information".

 Pepperl+Fuchs Group  
www.pepperl-fuchs.com

 USA: +1 330 486 0001  
fa-info@us.pepperl-fuchs.com

 Germany: +49 621 776 1111  
fa-info@de.pepperl-fuchs.com















 Singapore: +65 6779 9091  
fa-info@sg.pepperl-fuchs.com

 **PEPPERL+FUCHS**

## Technical Data

Combination 2 (Inox)	housing: stainless steel flange: stainless steel shaft: stainless steel
Mass	approx. 460 g (combination 1) approx. 800 g (combination 2)
Rotational speed	max. 12000 min <sup>-1</sup>
Moment of inertia	50 gcm <sup>2</sup>
Starting torque	< 5 Ncm
Shaft load	
Axial	40 N
Radial	110 N

## Accessories

	<b>9203</b>	Angled flange
	<b>9416</b>	Female cordset
	<b>9310-3</b>	Synchro clamping element
	<b>9300</b>	Mounting bracket for servo flange
	<b>KW-10/10</b>	Helical coupling
	<b>KW-6/10</b>	Helical coupling
	<b>KW-6/6</b>	Helical coupling
	<b>KW-6/8</b>	Helical coupling
	<b>9401 10*10</b>	Spring steel coupling
	<b>9401 10*12</b>	Spring steel coupling
	<b>9401 6*10</b>	Spring steel coupling
	<b>9401 6*6</b>	Spring steel coupling
	<b>9402 6*6</b>	Spring steel coupling
	<b>9404 10*10</b>	Spring disk coupling
	<b>9404 6*6</b>	Spring disk coupling

Release date: 2023-02-14 Date of issue: 2023-02-14 Filename: t49169\_eng.pdf

Refer to "General Notes Relating to Pepperl+Fuchs Product Information".

Pepperl+Fuchs Group  
www.pepperl-fuchs.com









USA: +1 330 486 0001  
fa-info@us.pepperl-fuchs.com

Germany: +49 621 776 1111  
fa-info@de.pepperl-fuchs.com

Singapore: +65 6779 9091  
fa-info@sg.pepperl-fuchs.com

 **PEPPERL+FUCHS**

## Accessories

	<b>9409 10*10</b>	Bellows coupling
	<b>9409 6*10</b>	Bellows coupling
	<b>9409 6*6</b>	Bellows coupling
	<b>9409 6*8</b>	Bellows coupling
	<b>9410 10*10</b>	Precision coupling
	<b>9410 6*6</b>	Precision coupling
	<b>MBT-36ALS</b>	Spring-loaded mounting bracket with a diameter of 36 mm
	<b>9416-*M-12P-AVM</b>	Female cordset, M23, 12-pin, PVC cable, 8-core

**Connection**

Signal	Cable Ø7 mm, 12-core	Connector 9416, 12-pin	Connector 9416L, 12-pin	Explanation
GND (encoder)	White	1	1	Power supply
U <sub>b</sub> (encoder)	Brown	2	8	Power supply
Clock (+)	Green	3	3	Positive cycle line
Clock (-)	Yellow	4	11	Negative cycle line
Data (+)	Grey	5	2	Positive transmission data
Data (-)	Pink	6	10	Negative transmission data
A	Blue	7	12	Incremental track A
V/R	Red	8	5	Input for selection of counting direction
PRESET 1	Black	9	9	zero-setting input
B	Grey/Pink	10	4	Incremental track B
$\bar{A}$	Violet	11	6	Incremental track $\bar{A}$
$\bar{B}$	Red/Blue	12	7	Incremental track $\bar{B}$

--	--

**Interface**

**Description**

The Synchronous Serial Interface was specially developed for transferring the output data of an absolute encoder to a control device. The control module sends a clock bundle and the absolute encoder responds with the position value. Thus only 4 lines are required for the clock and data, no matter what the resolution of the rotary encoder is. The RS 422 interface is optically isolated from the power supply.

**SSI signal course Standard**

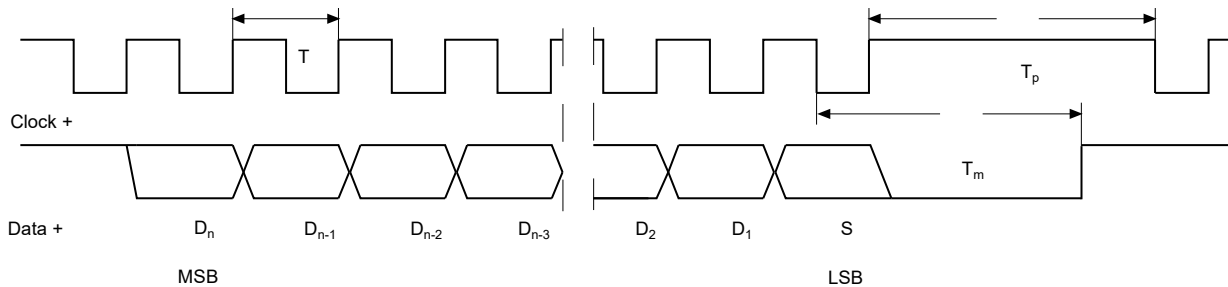

- D<sub>1</sub>, ..., D<sub>n</sub>: Position data
- S: Special bit
- MSB: Most significant bit
- LSB: Least significant bit
- T = 1/f: Duration of period of clock signal ≤ 1 MHz
- T<sub>m</sub>: Monoflop time 10 μs ... 30 μs
- T<sub>p</sub>: Clock pause ≥ monoflop time (T<sub>p</sub> ≥ T<sub>m</sub>)

**SSI output format Standard**

- At idle status signal lines "Data +" and "Clock +" are at high level (5 V).
- The first time the clock signal switches from high to low, the data transfer in which the current information (position data (D<sub>n</sub>) and special bit (S)) is stored in the encoder is introduced.
- The highest order bit (MSB) is applied to the serial data output of the encoder with the first rising pulse edge.
- The next successive lower order bit is transferred with each following rising pulse edge.
- After the lowest order bit (LSB) has been transferred the data line switches to low until the monoflop time T<sub>m</sub> has expired.
- No subsequent data transfer can be started until the data line switches to high again or the time for the clock pause T<sub>p</sub> has expired.
- After the clock sequence is complete, the monoflop time T<sub>m</sub> is triggered with the last falling pulse edge.
- The monoflop time T<sub>m</sub> determines the lowest transmission frequency.

**SSI output format ring slide operation (multiple transmission)**

- In ring slide operation, multiple transmission of the same data word over the SSI interface makes it possible to offer the possibility of detecting transmission errors.
- In multiple transmission, 25 bits are transferred per data word in standard format.

Release date: 2023-02-14 Date of issue: 2023-02-14 Filename: t49169\_eng.pdf

- If the clock change is not interrupted after the last falling pulse edge, ring slide operation automatically becomes active. This means that the information that was stored at the time of the first clock change is generated again.
- After the first transmission, the 26<sup>th</sup> pulse controls data repetition. If the 26<sup>th</sup> pulse follows after an amount of time greater than the monoflop time  $T_m$ , a new current data word will be transmitted with the following pulses.



If the pulse line is exchanged, the data word is generated offset. Ring slide operation is possible up to max. 13 bits.

**Block diagram**

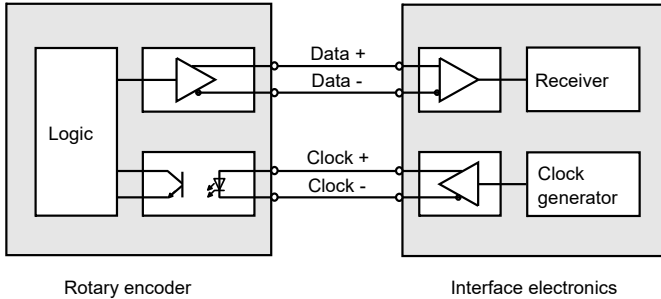

**Line length**

Line length in m	Baudrate in kHz
< 50	< 400
< 100	< 300
< 200	< 200
< 400	< 100

**Operation**

**Signal output**

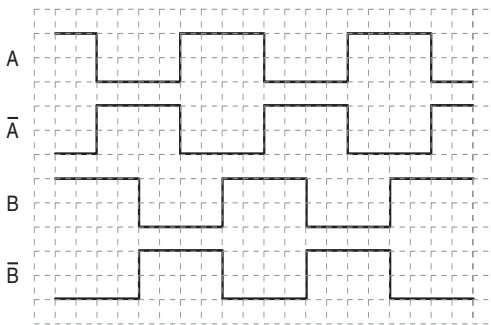

↻ cw - with view onto the shaft

**Inputs**

The selection of the counting direction input (cw/ccw) is activated with 0-level. The zero-set input (PRESET 1) is activated with 1-level.

zero-set input (PRESET 1)

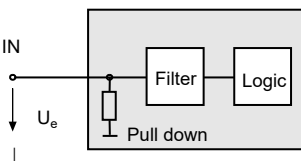

Input for selection of counting direction (cw/ccw)

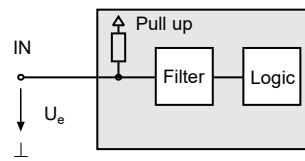

**Type Code**

Release date: 2023-02-14 Date of issue: 2023-02-14 Filename: t49169\_eng.pdf

**Order code**

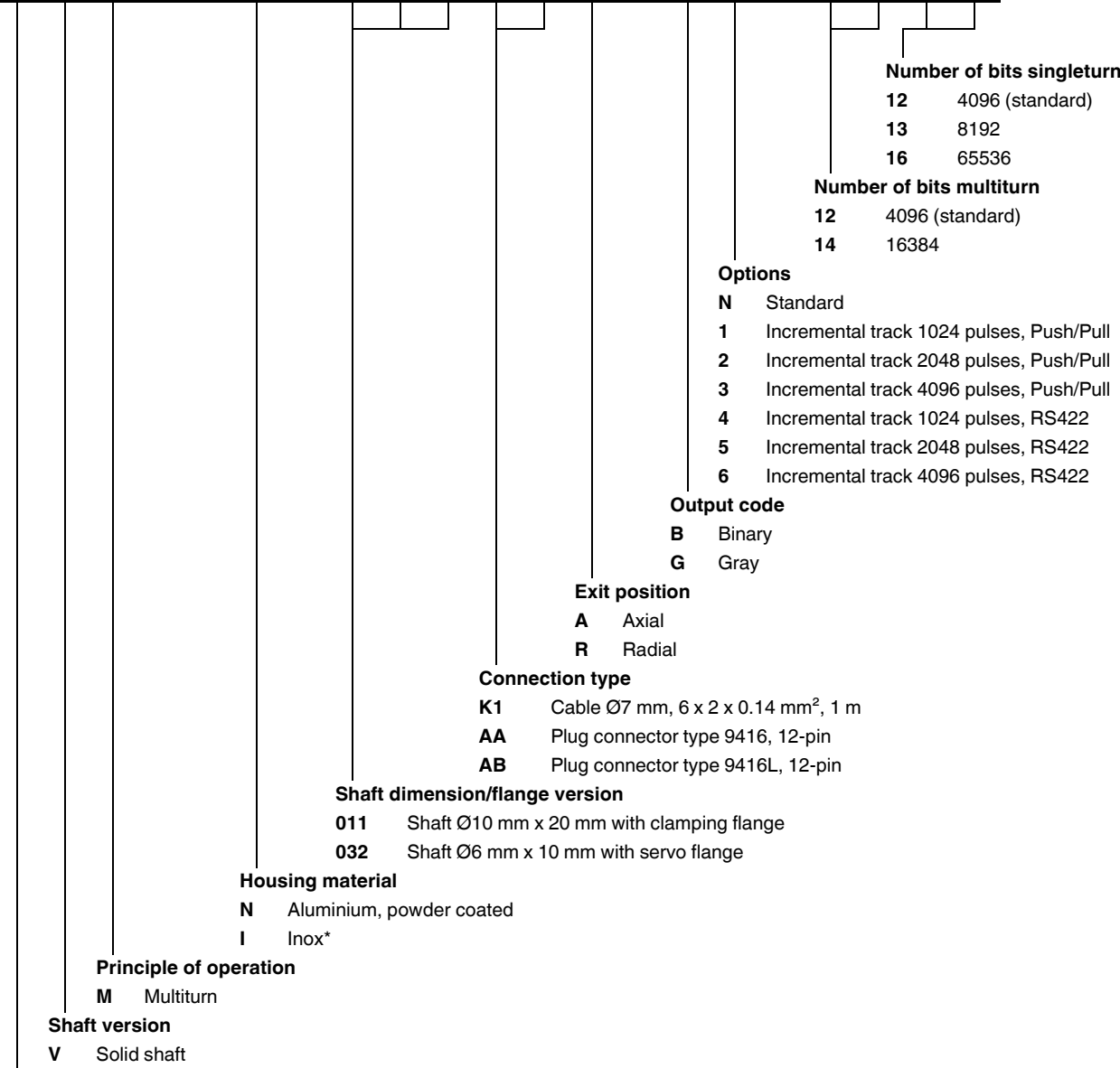

- Number of bits singleturn**
- 12 4096 (standard)
  - 13 8192
  - 16 65536
- Number of bits multiturn**
- 12 4096 (standard)
  - 14 16384

- Options**
- N Standard
  - 1 Incremental track 1024 pulses, Push/Pull
  - 2 Incremental track 2048 pulses, Push/Pull
  - 3 Incremental track 4096 pulses, Push/Pull
  - 4 Incremental track 1024 pulses, RS422
  - 5 Incremental track 2048 pulses, RS422
  - 6 Incremental track 4096 pulses, RS422

- Output code**
- B Binary
  - G Gray

- Exit position**
- A Axial
  - R Radial

- Connection type**
- K1 Cable Ø7 mm, 6 x 2 x 0.14 mm<sup>2</sup>, 1 m
  - AA Plug connector type 9416, 12-pin
  - AB Plug connector type 9416L, 12-pin

- Shaft dimension/flange version**
- 011 Shaft Ø10 mm x 20 mm with clamping flange
  - 032 Shaft Ø6 mm x 10 mm with servo flange

- Housing material**
- N Aluminium, powder coated
  - I Inox\*

- Principle of operation**
- M Multiturn

- Shaft version**
- V Solid shaft

- Data format**
- A SSI (Synchronous Serial Interface)

\*Housing material I only available with axial exit position.

Release date: 2023-02-14 Date of issue: 2023-02-14 Filename: t49169\_eng.pdf